

Instructions for use

FKI Clamshell Grill

CT 600-2

Type code: ACS-20



FKI Fast Food Teknik a/s

Version 1.3 – January, 2022

Contents

1	Introduction.....	4
1.1	General.....	4
1.1.1	Appliance description.....	4
1.1.2	Manufacturer.....	4
1.1.3	Appliance label.....	5
1.1.4	Technical specifications and power consumption.....	5
1.1.5	Modification.....	6
2	Safety.....	7
2.1	Personal safety equipment.....	7
2.2	Potential hazards.....	7
2.3	Who may use the appliance.....	8
2.4	Transport/installation /fixation.....	8
2.4.1	Transport.....	8
2.4.2	Installation.....	10
2.4.3	Fixation.....	11
2.5	Operation.....	11
2.6	Cleaning/maintenance.....	11
2.7	Servicing.....	12
2.8	Accessories.....	12
3	Operation.....	13
3.1	Before first use.....	13
3.2	Quick start instructions.....	13
3.3	Steak positioning.....	13
3.4	Start-up.....	14
3.5	Programming.....	15
3.5.1	Setting the individual programs.....	15
3.5.2	Settings that apply to all programs.....	18
3.5.3	Temperature and operating zone configuration.....	18
3.5.4	Setting the sound.....	20
3.5.5	Password setting.....	20
3.5.6	USB dongle.....	20
3.5.7	Calibration.....	21
3.6	Operation.....	21

3.7	Error codes.....	24
3.8	Spare parts.....	26
4	Electrical diagram	28
5	Cleaning	33
5.1	General	33
5.2	Cleaning during operation	33
5.3	Daily cleaning.....	33
6	Service	34
6.1	Adjusting the top pan	34
7	Disposal.....	35
7.1	Packaging.....	35
7.2	When the appliance is no longer in use	35
8	EU DECLARATION OF CONFORMITY	36

1 Introduction

Original user instructions

These instructions are FKI Fast Food Teknik's original instructions for appliance CT 600-2.

The purpose of these instructions

These instructions are intended to ensure the correct installation, use, handling and maintenance of appliance CT 600-2.



Important! Read these instructions carefully before use and keep them safe for later use.

Storage of these instructions

You must retain these instructions and make sure that they are easily accessible to users and service technicians.

Understanding these instructions

It is the responsibility of the appliance's owner (CT 600-2 owner) to ensure that anyone who will be operating, servicing, maintaining or repairing appliance CT 600-2 has read these instructions and, by way of minimum, the sections that are of relevance to the work they will perform.

Anyone who will be operating, servicing, maintaining or repairing appliance CT 600-2, is required to look up any relevant information in these instructions.

1.1 General

1.1.1 Appliance description

Appliance CT 600-2 is a fully-automatic contact grill for frying steaks and other foods. It is equipped with an alarm and separate heat control of top and bottom pans. It is a counter-top model. The appliance is equipped with electronic controls and a control screen for each heating section, for easy operation and programming. Appliance CT 600-2 makes it easy to achieve uniform high quality when frying your products. The appliance is equipped with a grease tray on each side so that excess grease from frying can be disposed of safely and efficiently.

1.1.2 Manufacturer

FKI Fast Food Teknik a/s
Byghøjvej 5, Verninge

DK-5690 Tommerup
Denmark
www.fki.dk

1.1.3 Appliance label

1.1.3.1 Type code: ACS-20



1.1.4 Technical specifications and power consumption

Breakdown of appliance CT 600-2 product name:

CT = Counter Top

600 = Model number

2 = Number of lids/hatches

1.1.4.1 Dimensions and weight

CT 600-2 dimensions and weight:

Depth: 710 mm

Width: 570 mm

Height when closed: 530 mm

Height when open: 920 mm

Weight: 96 kg.

1.1.4.2 Power

Voltage	Fuse	Power	Theoretical consumption per phase*		
			L1	L2	L3
400V 3N~	32A	12kW	19A	19A	13A
230V 3~	32A		29A	29A	19A

*Actual measured result can be expected to be lower.



The appliance should be connected to its own circuit.

1.1.4.3 Intended use

Appliance CT 600-2 may only be used to fry food.

1.1.5 Modification

Appliance CT 600-2 must never be modified or serviced by unauthorised persons. In the event of non-compliance, FKI Fast Food Teknik a/s waives any and all liability.

2 Safety

General

Read these safety instructions before using the appliance. Keep them near to the appliance for later reference. These instructions and the appliance itself are provided with important safety information that must always be read and observed at all times. FKI Fast Food Teknik a/s disclaims any and all liability for non-compliance with these safety instructions, for inappropriate use of the appliance or the use of incorrect settings.

Appliance CT 600-2 is a fully-automatic contact grill which is primarily intended for continuous frying of steaks (frozen or fresh). The appliance can also be used for other foods that are suitable for frying. To determine optimum temperature, time and thickness setting, a test fry is always recommended before commencing series production. Note that the nature of the food (thickness, temperature, surface, etc.) will affect the frying result.

It is equipped with a notification alarm which sounds when a program is finished and the lid will tilt up. The appliance may only be used in a dry environment and at room temperatures between 0°C - 40°C.

The appliance has built-in temperature monitoring. This is intended to interrupt power supply to the heating elements if a pan's temperature exceeds 300°C. Monitoring is performed by the appliance's control board. If this fails, the monitoring function will not work. The appliance must therefore be supervised by trained personnel during operation.

2.1 Personal safety equipment



It is recommended that gloves and goggles are worn when working with the contact grill and when emptying the grease trays, as the contact grill has hot surfaces and hot grease can be dangerous.

2.2 Potential hazards



The surfaces of the contact grill and especially the upper and lower frying pans, but also the cabinet on the upper frying pan are very hot and are labelled with this warning sign:



Therefore, be careful not to touch them while operating the contact grill.

During operation, only the buttons and the touch screen on the front may be touched. The food that is fried on the pan must be inserted and removed using a specially designed tool to avoid contact with the hot surfaces of the contact grill.



Regularly check that the handles on the grease trays are securely tightened to ensure safe handling of hot oil/grease. If a handle is loose, remove the screws, apply a food grade adhesive to the threads and then retighten, or contact a service technician.

2.3 Who may use the appliance



This appliance is not intended for use by children! Neither should it be used by persons with reduced physical or mental capacity, or who lack appropriate experience and knowledge unless they have been trained or instructed in the use of the appliance by someone with responsibility for their safety.

2.4 Transport/installation /fixation

2.4.1 Transport

The contact grill is delivered secured to a transport pallet, and should only be transported in the same way if moved. During transportation both top pans must be lowered, as shown in the picture below.

Lifting points on the appliance are shown below and are for use when lifting it into place. At the front, grasp beneath the pan on each side. The back of the appliance can be lifted under the rear cabinet. Always remove the grease trays before moving the appliance.

WARNING: Never lift using the arms of the top pans or the two black cable routings. This applies during both installation and operation.





Moving and setting up the appliance must be performed by two or more people due to RISK of injury!
Wear protective gloves and safety footwear during unpacking and installation.
Cut hazard.

2.4.2 Installation

Set up the contact grill on a counter or similar at a suitable working height (We recommend a counter height of 65 cm to achieve a working height of 90 cm).

The counter on which the contact grill is set up must be approved for the appliance's weight plus 25%, and must not be able to tip over when using the appliance. The contact grill must be supported under all four legs.

Operation takes place from the front of the contact grill. For correct ventilation there must be free passage of air underneath and behind the appliance. The contact grill must be placed under an extraction hood or some other form of cooking fumes extraction. We do not recommend placing the CT600-2 next to a fryer.

The contact grill is supplied without a plug, and must be connected by an authorised electrician. It is important that the cable is not bent or compressed during installation. Bend radius must not exceed 52mm when fitted.



The contact grill must be connected by an authorised electrician, and connected to an RCCB circuit breaker.

For correct connection see diagram:



WARNING: This appliance must be properly earthed. Failure to do so may cause electric shock and serious injury.



The appliance must be acclimatised before use. It should not therefore be started up until eight hours have elapsed.



The power supply must be able to be disconnected, either by unplugging or by means of a freely-accessible multi-pole switch located before the power outlet in accordance with applicable electricity regulations. The appliance must be earthed in accordance with national safety standards for electrical appliances.



Do not use extension cords or multi-socket outlets. After installation is completed there must be no direct access to the electrical components. Never touch the appliance if you are wet or have bare feet. Do not use this appliance if the power cord or plug is damaged, if the appliance is not working properly, if it is damaged or if it has been dropped on the floor.



Any replacement of the power cord must be performed by an authorised technician to avoid the risk of personal injury - RISK of electric shock. Only use oil-resistant cables!

2.4.3 Fixation



The appliance does not need to be secured. It is equipped with adjustable legs to ensure stable and easy installation.

2.5 Operation



When the lid closes, there is a risk of getting your hand trapped. The lid is loosely mounted and will only squeeze with its own weight and can be tilted up to release yourself.

The appliance must be supervised during use and must be switched off at its main switch if left.



Appliance CT 600-2 is intended for food preparation only. Do not apply liquids or other substances that have an ignition point below 300° C.



When the lid is open, it must not be forced further upwards manually, as this may damage the lift-system and disrupt the calibration of the appliance.

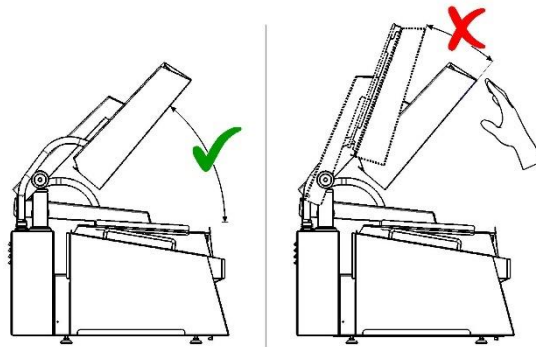

2.6 Cleaning/maintenance



CLEANING AND MAINTENANCE WARNING: Check that the appliance is set to the cleaning program before performing daily cleaning or maintenance tasks. Do not use products that contain acid, as they may damage the surface of the appliance.



Never use steam/foam cleaners due to RISK of electric shock.

2.7 Servicing



The appliance must always be switched off and disconnected from the power source before commencing repair work.

2.8 Accessories



Teflon film: Only original FKI Fast Food Teknik a/s Teflon foil may be used on appliance CT 600-2. This film must not be used on other appliances.

3 Operation

3.1 Before first use



Before start-up, remove all packaging and protective plastic from the contact grill and dispose of it in accordance with currently applicable regulations (see section 7.1). Carefully read section 2 about safety before connecting the contact grill.



Before start-up, clean the appliance as shown in section 5.

3.2 Quick start instructions

Before start-up, read section 5.1 under “cleaning”. If you intend to use Teflon film, this should be fitted before start-up. To achieve the best frying results, we recommend that Teflon is used on the top pan. This will also make cleaning easier. Place the grease trays on either side of the contact grill.

Press the gear  icon to program the contact grill. Set top and bottom pan temperature, the thickness of the steak and fry time (see section 3.5 for programming).

Press  “start” on the display and wait 30 minutes for the contact grill to heat up and become ready for use.

The appliance must not be operated unattended.



Remember to use personal safety equipment, see 2.1

3.3 Steak positioning

For optimal steak frying, we recommend that they are positioned as shown in the pictures. If a different quantity of steaks is used, position them symmetrically starting from the centre of the frying zone.

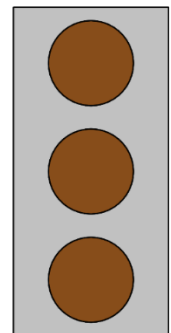
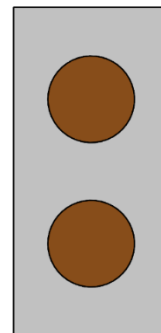
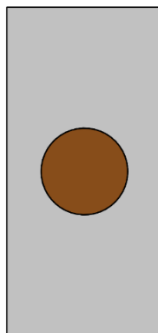

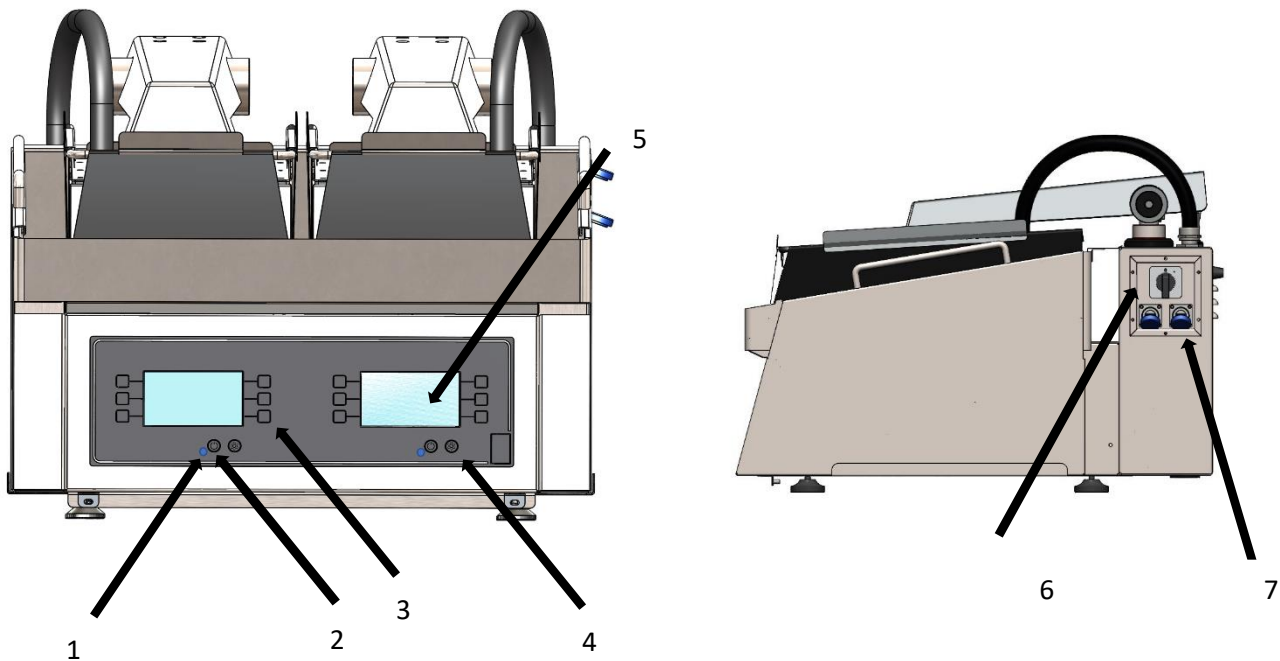

3.4 Start-up

Explanation of the CT 600-2 user interface:



No.	Description
1.	Light
2.	Start
3.	Program buttons
4.	Settings
5.	Screen
6.	Switch
7.	USB port max 4GB (top port = left side)

If you intend to use Teflon film, this should be fitted before start-up. See the installation video on our website <https://fki.dk/produkter/kontaktgrill/folieholder/>. Check that the grease trays are positioned correctly on each side of the appliance.

Turn the switch (6) on the side of the appliance and the light (1) on the front of the appliance  will turn on. Press to turn on the appliance, or press  to configure the appliance.

CT 600-2 is supplied with the following factory settings:

Temperature: 240 ° C / 225 ° C (Top / Bottom)
Thickness: 12 mm (Distance between the pans)
Fry time: 2:40 minutes

Factory settings can be reloaded by creating a blank text file on a USB dongle named

"factory.txt" and load the file under USB settings.

After use, always switch the appliance off at the main switch.

3.5 Programming

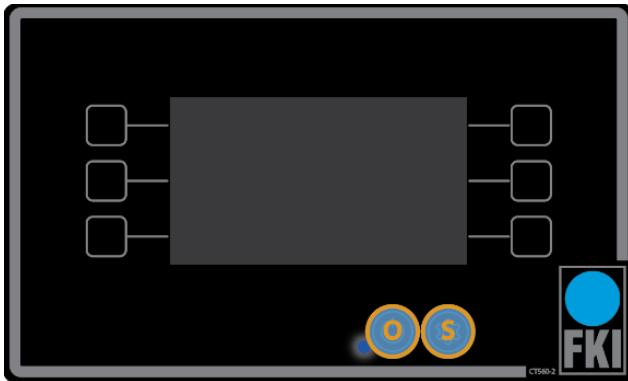

Standby

Press **O** to enter daily operation, see section 3.6 (during operation only the buttons can be used, not the screen).

Press **S** to go to settings or cleaning program, see section 3.5.1 (in "settings" the touch screen is used instead of the buttons. Here only the "S" button works).

3.5.1 Setting the individual programs

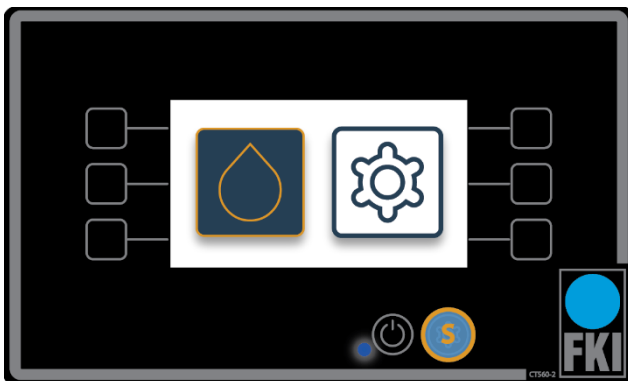

Once **S** is selected, you have two options: cleaning program or go to settings.

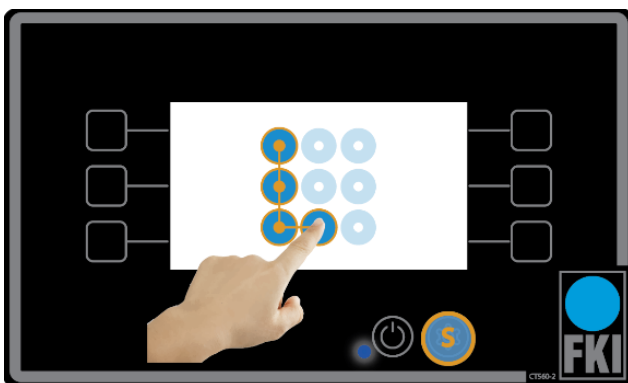

Access control

Entering the settings menu requires entry of a default password, which is shown here on the screen. This can be changed in "password setting" or you can deactivate it. We recommend, however, that password is always enabled.

Forgotten passwords can be reset to the factory setting as follows:

1. Create a blank text file on a USB dongle named "pinreset.txt"
2. Press **S** to enter *standby* mode.
3. Insert the USB dongle into the corresponding USB port.
4. Press **S** to return to *access control*. The password is now reset and is as shown in the picture.

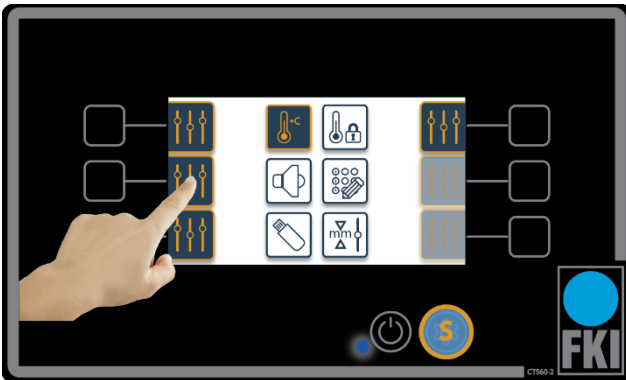

Home screen

This picture shows the home screen in the settings menu. To set one of the six programs, press  next to the program you want to configure.

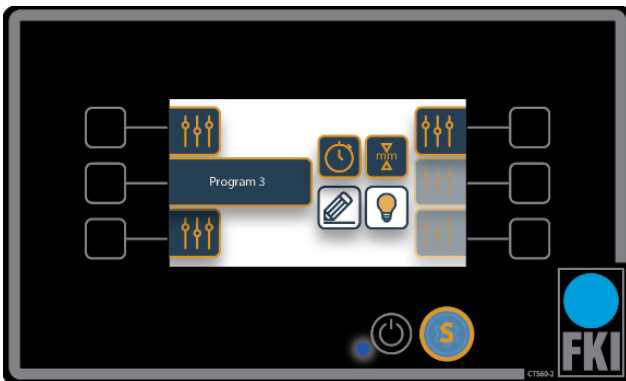

Program settings submenu

Here, Program 3 is selected. It is now possible to set cooking time, thickness and program name. Pressing the light bulb icon allows you to deactivate the program if it is not required (settings are stored even if the program is deactivated).

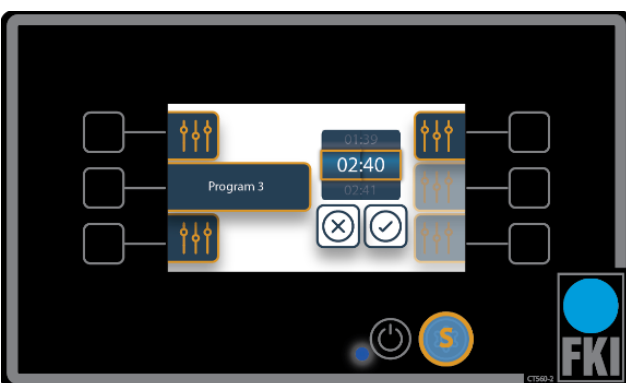

Time setting

Here fry time for Program 3 is selected. When you have selected the correct time, approve it and you will then return to the previous screen.

If a program time setting is 00:00, the timer will function as a *stopwatch* and will count upwards from zero seconds.

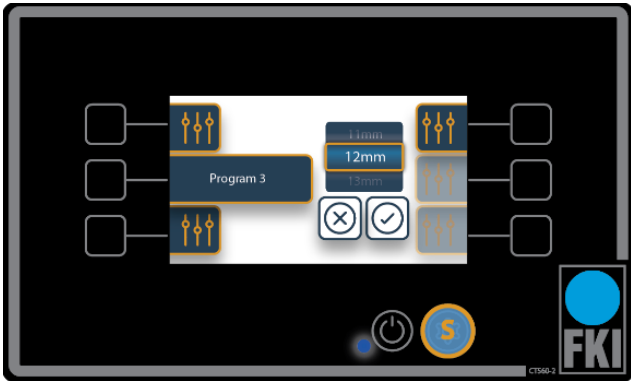

Height adjustment

Here thickness settings are selected. This is performed in the same way as when setting the timer; turn the wheel to the right thickness and approve.

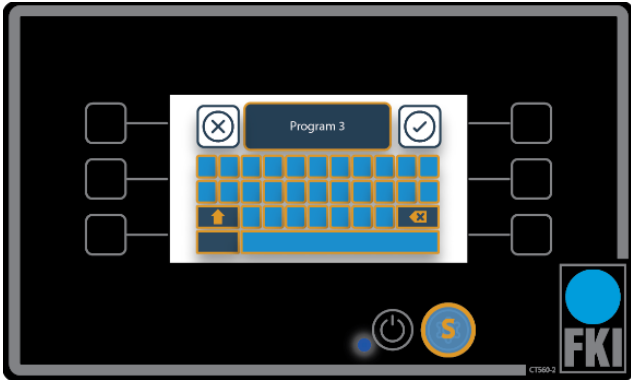

Edit program name

Here, the program name is selected. Enter the name you want to use and approve.

3.5.2 Settings that apply to all programs

Explanation of symbols for this section:

	Temperature
	Temperature Operating zone
	Sound
	Password
	USB port
	Calibration

3.5.3 Temperature and operating zone configuration



Temperature

If you press “temperature setting” on the home screen, this screen will appear.

Here, you have the option to set the temperature for the top and bottom pans, approve the set temperature, and return to the *home screen*.



Operating zone temperature

This picture shows the screen that will appear if you tap this icon.

Here you have the option to select a temperature range to ensure that the appliance always fries to perfection. When temperature is outside the selected range, the screen will lock until it is ready again.

The following two pictures show what is displayed on the screen if the appliance is too hot or not hot enough. This option can be changed to show a colour indication in the main menu as to whether one or both pans are too hot or not hot enough. This allows the user to ignore the warning. It is also possible to completely remove this indication.

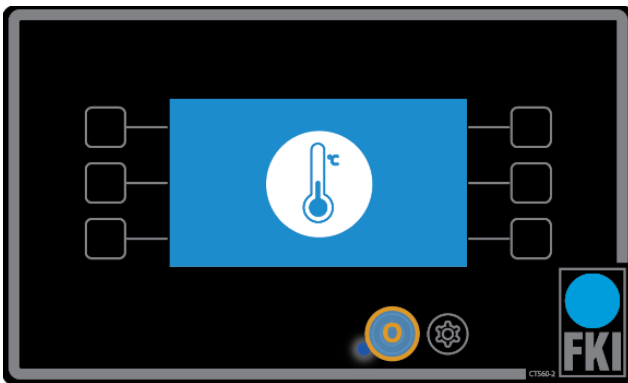

Screen if the appliance is not hot enough.

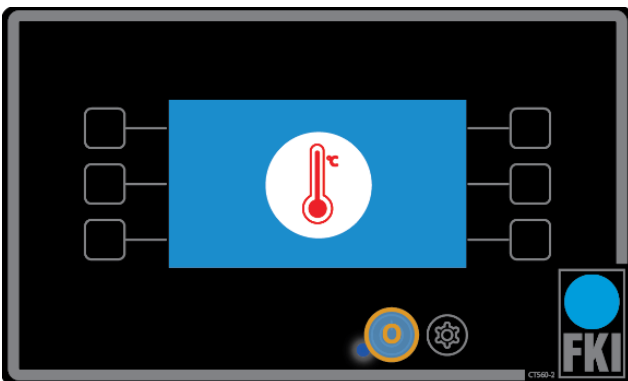

Screen if the appliance is too hot.

3.5.4 Setting the sound



Sound

When adjusting the sound settings it is possible to set the volume as a percentage, and a time for how long the notification should sound when the program is completed.

3.5.5 Password setting

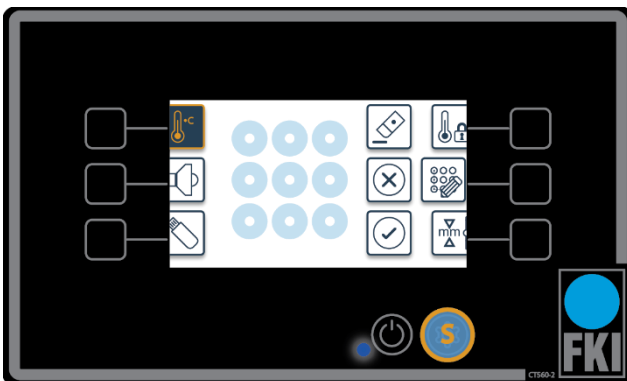

Password

Here, you have the option to change the password that is required to enter the settings menu, or deactivate the password completely. Deactivate the password by entering an empty password and clicking "OK".

3.5.6 USB dongle

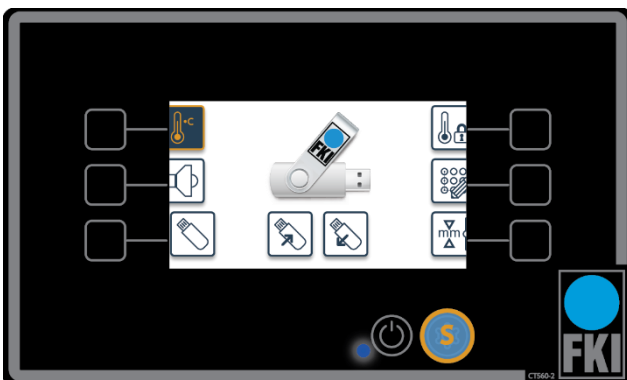

USB port

The USB port allows you to upload programs, or save them externally. The icon only becomes active when a USB dongle is inserted. The top USB port is for the left screen and the lower one is for the right screen. The capacity of the USB dongle must not exceed 4GB.

NB! If the the USB dongle contains a settings file and the dongle is read or written, the settings will be

overwritten without asking for permission.

3.5.7 Calibration



Calibration

It is not possible during calibration to adjust the height of the top pan relative to the bottom pan if the setting is incorrect. So if the pan is set to 10mm and it is only 8mm, it should be set to + 2mm. This setting will then work on all programs.

If the top pan is not parallel to the bottom pan, see section 6.1 for adjustment.

3.6 Operation

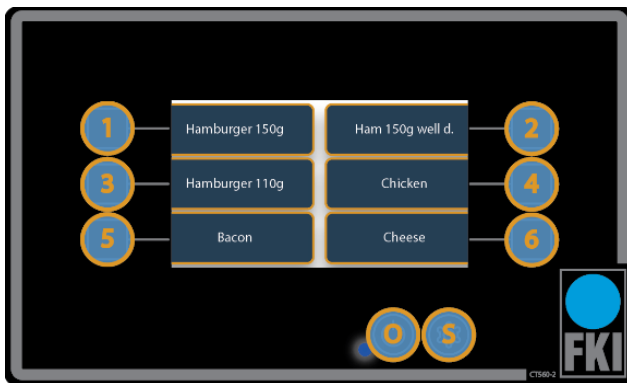

Home screen

This is the home screen during operation.

Press 1-6 to start a program.

Press **O** to switch off or go into *standby*.

Press and hold **S** for 3 seconds to display a graph of temperatures over the last 3.5 hours.

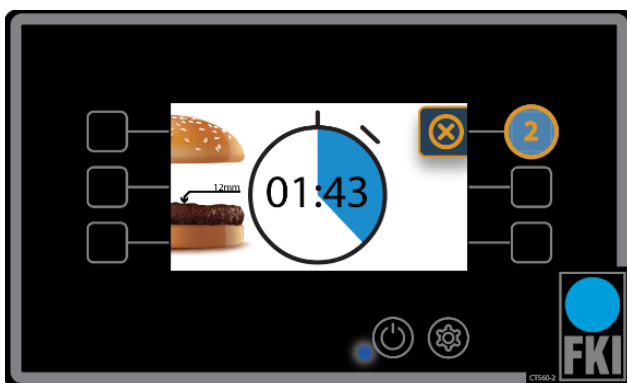

Program active

If program 1-6 is selected on the home screen, this screen will appear. Here, program 2 is selected. This shows the program's thickness setting and time remaining. If you want to stop frying before the set time has expired, press the selected program (here, program 2) and you will return to the *home screen*.

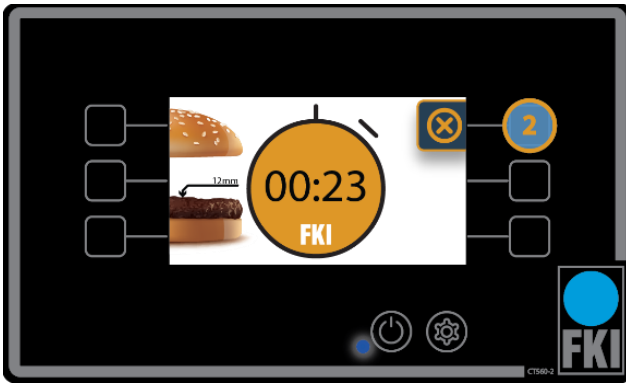

Stopwatch

This picture shows the stopwatch function that operates if time is set to 00:00 in a program and is not adjusted.

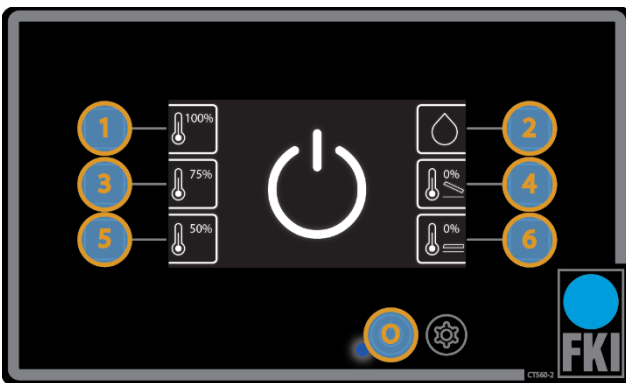

Shutdown

If **O** is pressed on the home screen, you will see this screen, from where you can enter energy saving mode for reduced power consumption, using buttons 1, 3 and 5. The lid will close when this function is selected.

Programs 4 and 6 switch off the appliance when the lid is open or closed, respectively. If no selection is made, the appliance will enter *standby* when the lid

has been open for 15 seconds. Program 2 is cleaning

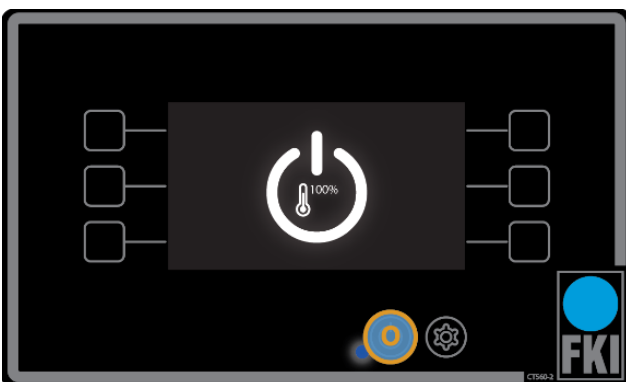

Energy-saving mode

Here, 100% heat is selected.

To return to the home screen, press **O**.

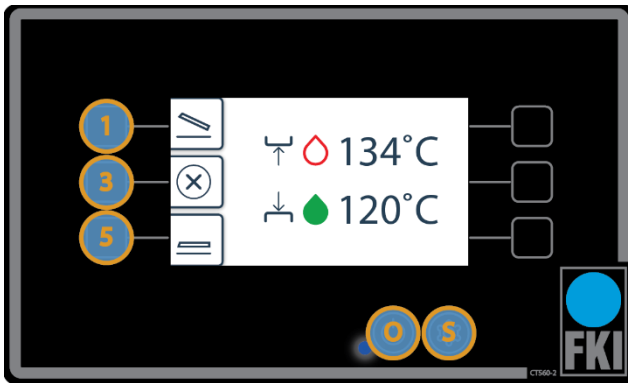

Cleaning program

Both pans will be shown as green when ready. At settings 1-5 the pans can be opened and closed. If you want to stop the pans at a certain position, press 3. When the pans are ready, they will have a temperature of approx. 160°.

To exit the program, press **O** or **S**

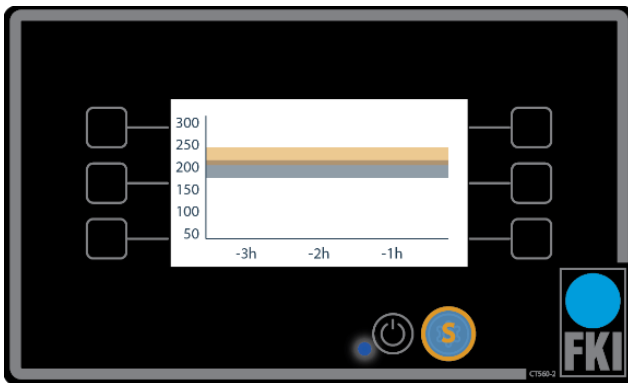

Temperature graph

If **S** is held down on the *home screen* for three seconds, this image will appear for about 10 seconds before the screen automatically returns to the *home screen*. The temperature graph shows the temperature for the last 3.5 hours, as well as the current temperature.

If you want to leave this prematurely then press **S**.

3.7 Error codes

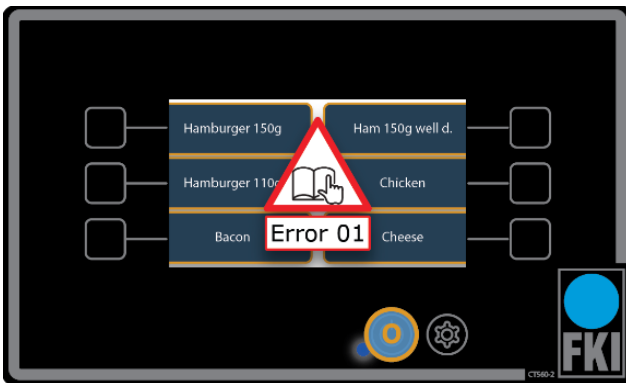

Error codes

In the event of a failure in the appliance, an error message like those shown here will appear. Find the error code in the below chart and try to rectify the error, or contact service.

ERROR CODE	ERROR	CAUSE	REMEDY	SW version
01	Communication error	Graphical user interface does not respond to control print.	Turn off the power for 10 seconds using the switch on the side of the appliance. If the error persists, contact service.	0.9.0000 ->
02	No status report	The control print does not deliver status reports to the graphical user interface.	Turn off the power for 10 seconds using the switch on the side of the appliance. If the error persists, contact service.	0.9.0000 ->
10	Top pan is overheated	The solid state relay may have short-circuited.	Contact service.	0.9.0000 ->
11	Bottom pan overheated	The solid state relay may have short-circuited.	Contact service.	0.9.0000 ->
12	Temperature sensor failure on top pan	The measured values are either too high or too low in relation to those expected.	Contact service.	0.9.0000 – 0.9.0013
		The measured values are either too high in relation to those expected.	Contact service.	0.9.0014 ->

13	Temperature sensor failure on bottom pan	The measured values are either too high or too low in relation to those expected.	Contact service.	0.9.0000 – 0.9.0013
		The measured values are either too high in relation to those expected.	Contact service.	0.9.0014 ->
14	Temperature sensor failure on top pan	The measured values are too low in relation to those expected.	The environment is either too cold or the sensor is short-circuited. In the latter case, service must be contacted	0.9.0014 ->
15	Temperature sensor failure on bottom pan	The measured values are too low in relation to those expected.	The environment is either too cold or the sensor is short-circuited. In the latter case, service must be contacted	0.9.0014 ->
20	Motor is overloaded	Motor failure/malfunction or there is too much friction on the lever.	Try cleaning the appliance's moving parts. If the error persists, contact service.	0.9.0000 ->

3.8 Spare parts

Spare parts diagram with parts list and part numbers.

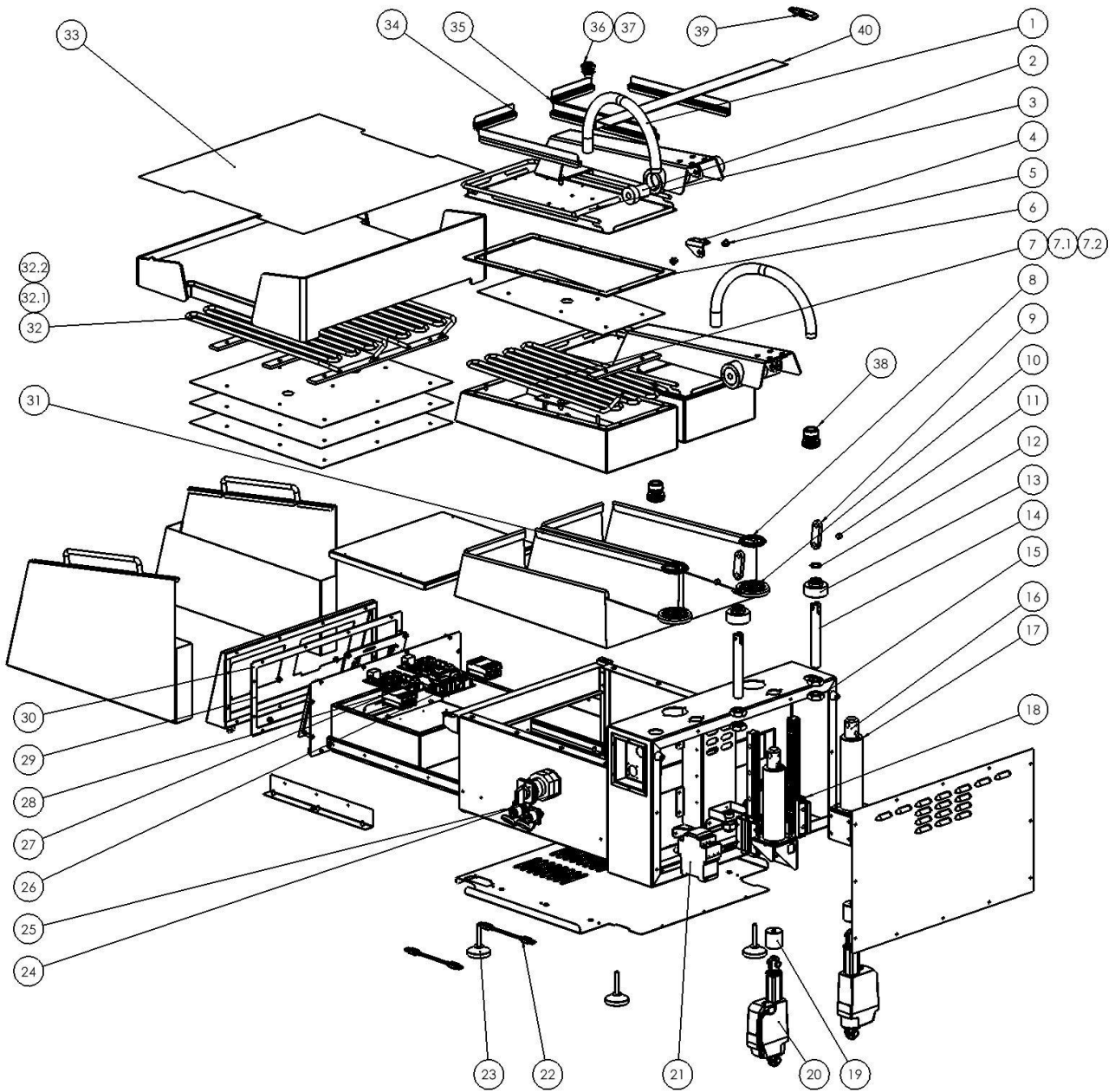

POS	Item no.	PCS	Description
1	72-00016	2	Tube GS/TPR/GLAT Ø16 Black
2	83-00643	4	bearing for lifting arm CT600-2
3	83-00679	2	shaft for lifting arm Ø12 CT600-2
4	83-00647	2	anchor bracket CT600-2
5	83-07890	4	Bearing Bronze ø6/10x10 M KRAVE ø14x2
6	83-00600	2	Gasket for upper pan CT600-2
7	83-10806	2	Heat element CT600-2 upper/lower 3KW/400V
7.1	83-10805	2	Heat element CT600-2 upper/lower 3 KW/3x230V
7.2	83-10075	2	temperature sensor PT100 1,8m
8	83-00646	2	sealing WR01 Viton 48x56x4/7
9	83-00657	2	link for lifting arm CT600-2
10	83-00653	2	support ring CT600-2
11	83-07918	2	Bearing- ø8/10x8
12	83-00682	2	O-RING O-R FEP/V 20,00x2,40
13	83-00652	2	ring for anchor CT600-2
14	83-00650	2	Bracket for arm CT600-2
15	78-04592	4	Lock Nut M20 A2
16	83-00651	2	Pipe for lifting bracket CT600-2
17	78-00840	2	screw, PINOL- M8x0,75x40 SORT
18	83-00280	2	linear guidance
19	83-00681	2	POM ring f. aktuator
20	83-10803	2	AKTUATOR LA23 110MM 1200N 24VDC
21	72-07020	1	CONTACTOR LC1D25BD 25A 24VDC
22	72-07014	2	CABLE USB A MALE/MALE 2m
23	82-06523	4	Leg Ø50/M8
24	83-41013	1	Switch 4-POL telux 50A
25	72-07015	2	Plug USB LP-24-USB3.0-S01
26	72-07013	1	PSU 240VAC / 24VDC 130W
27	72-07010	2	PRINT CTL
28	83-10316	4	SOLIDSTATE Relay 50A
29	72-07009	2	PRINT GUI
30	83-00601	1	Gasket FRONT CT600-2
31	01-10110	2	Teflonsheet CT600-2 top
32	83-10806	2	Heat elemet CT600-2 upper/lower 3KW/400V
32.1	83-10805	2	Heat element CT600-2 upper/lower 3KW/3x230V
32.2	83-10074	2	temperature sensor PT100 0,6m
33	01-10111	1	Teflonsheet CT600-2 Buttom
34	83-08484	2	Teflon clamp, short
35	83-08346	4	Teflon clamp, long
36	72-00019	2	FITTING 45° M16x1.5 MALE THREAD FOR 3/8"
37	72-00012	2	Gasket 3/8" PTFE white
38	72-00013	2	M32
39	07-00205	1	USB STICK 4GB FKI LOGO
40	83-00694	1	Protection screen CT600-2

400 V 3N~

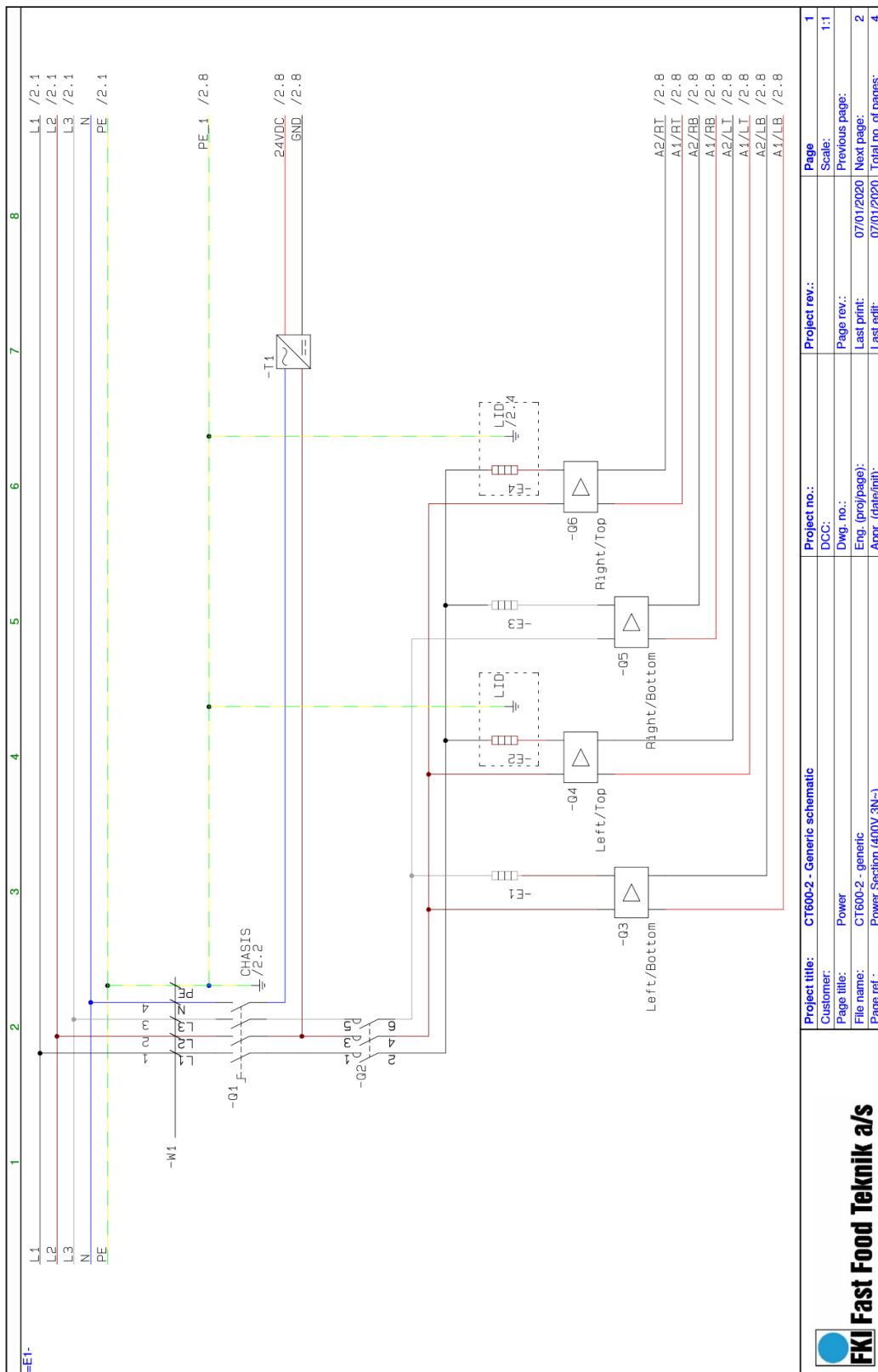

Project title: CT600-2 - Generic schematic	Project no.:	Page: 1
Customer: Power	DCC:	Scale: 1:1
Page title: Power	Page rev.:	Previous page:
File name: CT600-2 - generic	Eng. (prof/page): 07/01/2020	Next page: 2
Page ref.: Power Section (400V 3N~)	Appr. (date/init):	Last page: 4
		Total no. of pages: 4



FKI Fast Food Teknik a/s

230V 3~

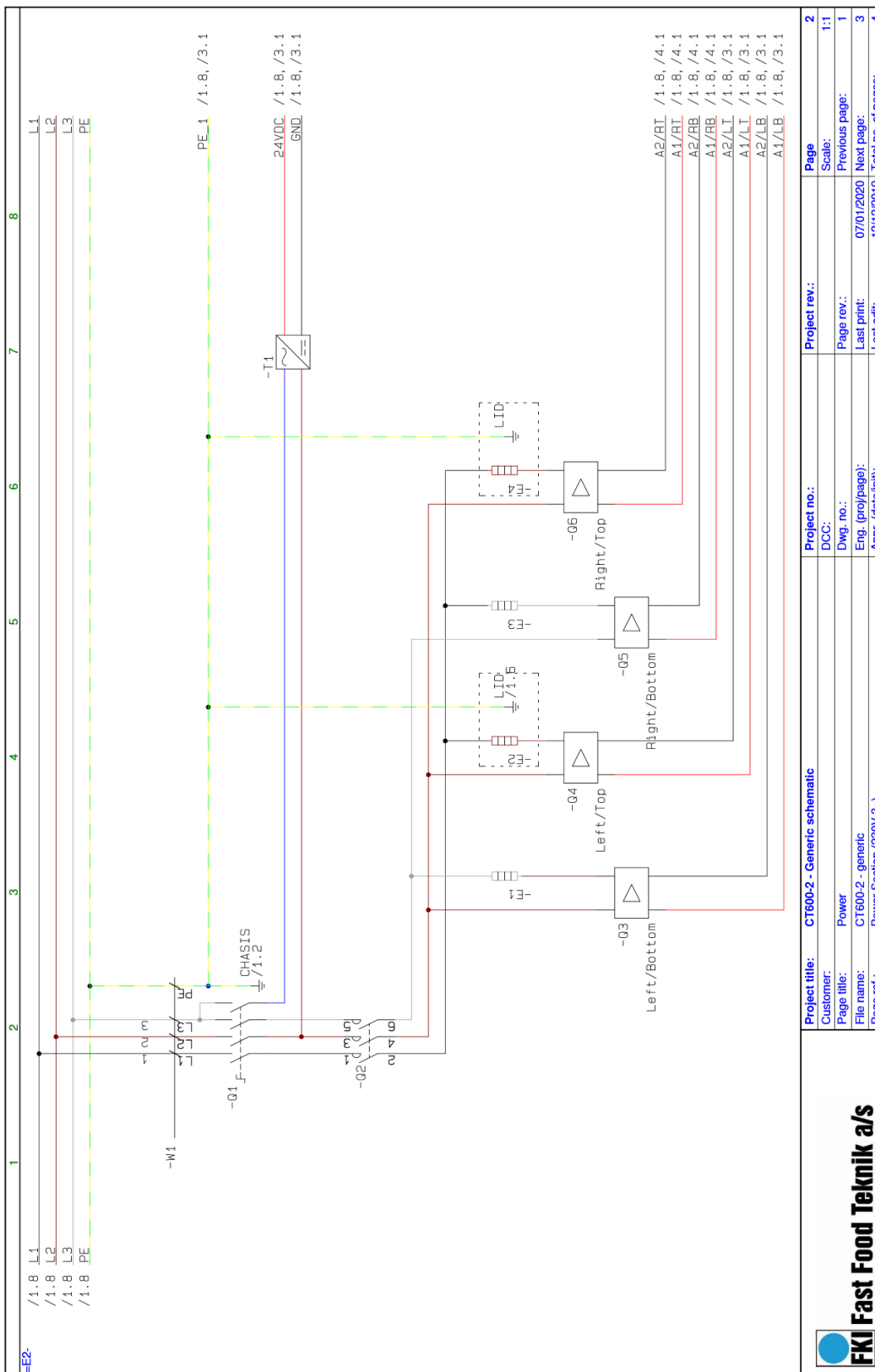

Project title: CT600-2 - Generic schematic	Project no.:	Project rev.:	Page
Customer: Power	DCC:	Scale:	2
Page title: Power	Dwg. no.:	Page rev.:	1:1
File name: CT600-2_generic	Eng. (proj/page):	Last print:	Previous page:
Page ref.: Power Section (230V 3~)	Appr. (date/ini):	Last edit:	1
			3
			4



FKI Fast Food Teknik a/s

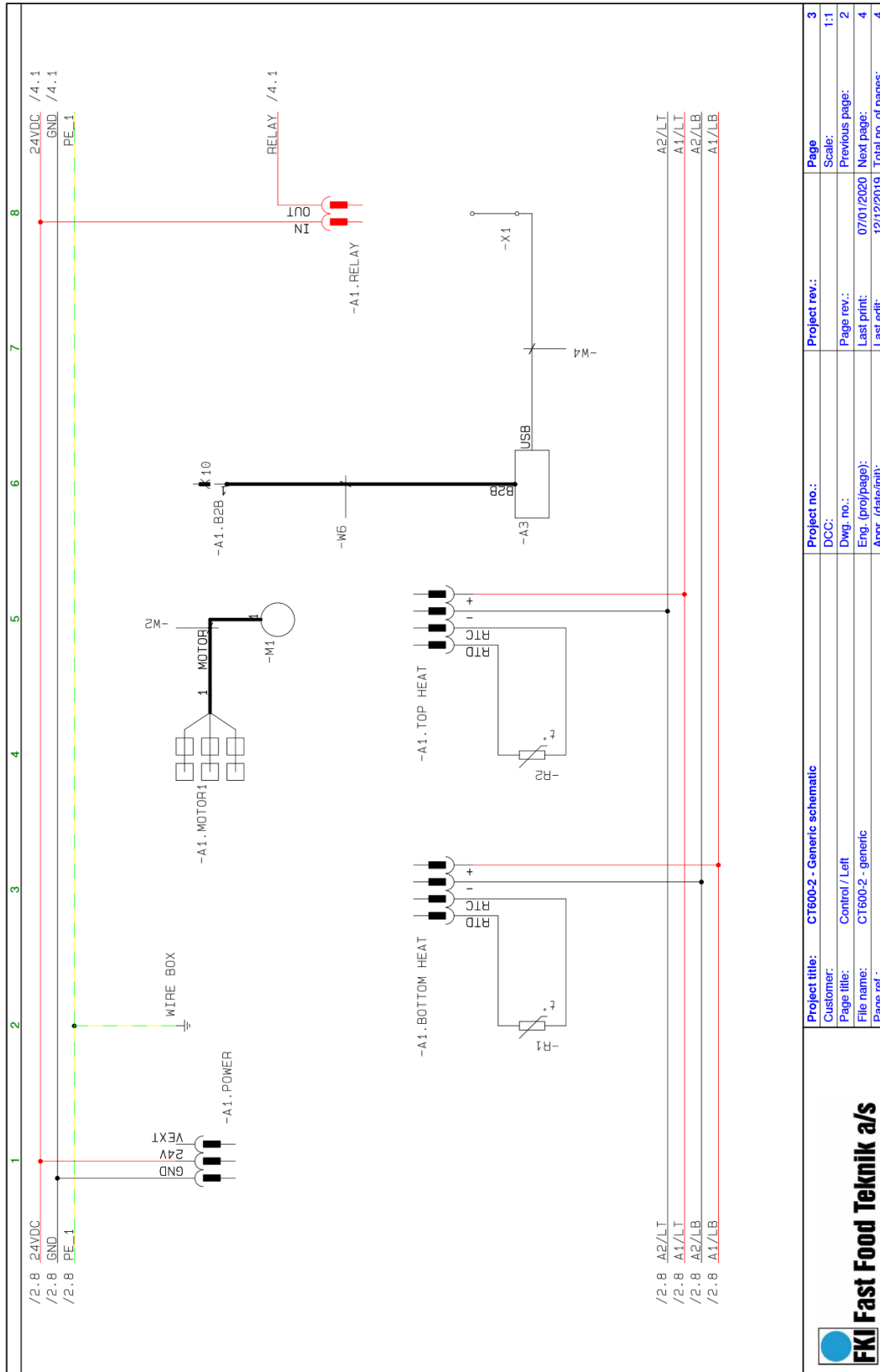

Project title: CT600-2 - Generic schematic		Project no.:	Project rev.:	Page
Customer:	Control / Left	DCC:		Scale:
Page title:	Control / Left	Dwg. no.:		Previous page:
File name:	CT600-2 - generic	Eng. (prop/page):	07/01/2020	Next page:
Page ref.:		Appr. (date/init):	12/12/2019	Total no. of pages:



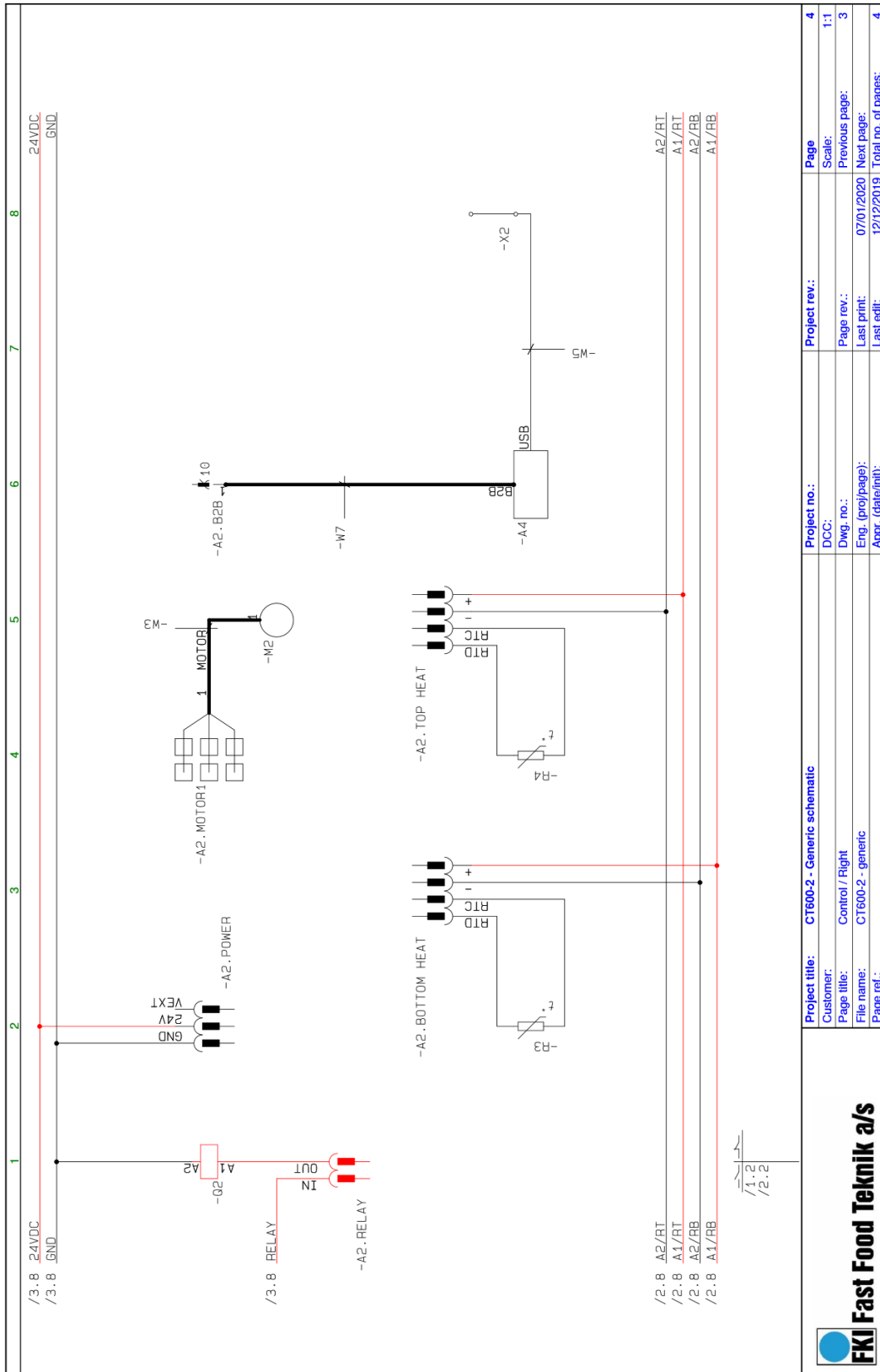

Project title: CT500-2 - Generic schematic		Project no.:	Project rev.:	Page
Customer: Control / Right		DCC:		4
Page title: CT500-2 - generic		Eng. (proj/page):	Page rev.:	Scale:
Page rel.:		Appr. (date/init):	Last print:	1:1
			07/01/2020	Previous page:
			12/12/2019	Next page:
				Total no. of pages:
				4



5 Cleaning

5.1 General

Before using the appliance for the first time, wipe all surfaces that will be in contact with food with a damp cloth. Do not use cleaning products that contain acid.

5.2 Cleaning during operation

After each fry, first scrape the top pans and then scrap all grease from the bottom pan into the grease trays. Empty grease trays as required. NB! Remember that the oil/grease you are emptying during this operation is very hot!

NB! Remember to use the correct scraper, depending on whether your pans are coated with the Teflon film or the contact grill is used without Teflon.



Remember to use personal safety equipment. see 2.1

5.3 Daily cleaning

Set the contact grill to the cleaning program and wait until it is ready, when the top and bottom pan light up green in the display. The temperature of the pans will be approx. 160°C, so remember to use safety equipment.

1. If the contact grill is fitted with Teflon, disassemble it (see section 3.4) and wash with a mild acid-free cleaner.
2. First, clean the pans with a scraper to remove all loose particles.
3. Then scan the below QR code and follow the instructions shown in the video for proper cleaning.
4. After cleaning the pan, turn off the appliance. After it has cooled down, wipe it with a damp cloth and mild acid-free cleaner. [See video for instructions](#)
5. Empty the grease tray and wash it.
6. The Teflon foil can then be put back into place.



6 Service

Find out if it is possible to correct the failure by following the instructions in the troubleshooting chart. If not, contact your dealer or www.fki.dk for assistance.

When contacting service for assistance, please have the following

- Sequential serial number located on the back of the appliance
- Type and model name are in the same position.

The machine plate is on the side of the appliance (see picture).

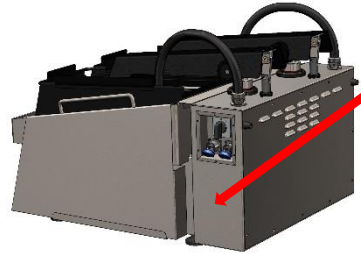

Before commencing repair work, the appliance must always be switched off and disconnected from the power source. Both diodes on the front must have gone out before accessing electrical components.

To make it easy to service a CT 600-2, most electrical parts are mounted in a closed drawer system that can be pulled out at the front. For access, remove two screws under the front section, which will allow the drawer to be pulled out.

After completing service work on the CT 600-2, check and reattach all cables, making sure that they are secured and will not be trapped by the moving parts. Likewise, wires that exit behind the drawer system should be secured with a strip to prevent them getting pinched when carefully closing the drawer.

6.1 Adjusting the top pan



If it is not parallel to the bottom pan, the top pan can be adjusted at the back of the appliance. This is done using a grub screw on the rear of the arm (see picture).



7 Disposal

7.1 Packaging

The packaging should not be left in the environment, but should be disposed of in accordance with local regulations.

7.2 When the appliance is no longer in use

CT 600-2 is labelled with a recycling symbol in accordance with Danish Executive Order 148 of 8 February 2018 (Electronic Waste Executive Order/Danish-Elektronikaffaldsbekendtgørelsen). WEEE2 directive 2012/19/EU

This means that you must dispose of it in accordance with your municipality's regulations, e.g. in a container set up for this purpose at the municipality's recycling centre when the appliance is worn out.



8 EU DECLARATION OF CONFORMITY



EU DoC ID: FKI 006
Verninge, 1. oktober 2021

EU DECLARATION OF CONFORMITY

We FKI Fast Food Teknik a/s declares under our sole responsibility that the product Clamshell Grill with

Type Code.:

ACS-20

are in conformity with the following directive(s), standard(s) or other normative document(s), provided that the products are used in accordance with our instructions.

Directives	Standards
Machine Directive 2006/42/EC	EN 12100:2010 EN 60335-1:2012 + AC:2014 + A11:2014 EN 60335-2-38:2003 + A1:2008
Electromagnetic Compatibility Directive 2014/30/EU	EN 55014-1:2006 + A1:2009 + A2:2011 EN 55014-2:1997 + A1:2001 + A2:2008
WEEE Directive 2012/19/EU RoHS Directive 2011/65/EU	
Regulations	Standards
Food Contact Materials 1935/2004 Good Manufacturing Practice 2023/2006	N/A

Date 4/10-2021	Issued by  Søren B. Jensen - Technical Director
-------------------	---

FKI Fast Food Teknik a/s only vouches for the correctness of the English version of this declaration. In the event of the declaration being translated into any other language, the translator concerned shall be liable for the correctness of the translation.



Fast Food Teknik a/s

Byghøjvej 5 · Verringe · DK-5690 Tommerup · Denmark · Tel. +45 6475 1066 · info@fki.dk ·